

# CATALOG



## What's New in the Catalog

### New Items:

Page 5, Thermal Transfer Labels with 1" cores in both 4" and 5" OD.

Page 8, General Purpose Wax Ribbon (Item# 750291) and Cleaning Cards for Thermal Printers (Item# 84086 and Item# 84087).

Pages 11 and 12, Non top coated Direct Thermal labels for most of our popular sizes with 3/4" and 1" cores.

### Contact Us:

847-628-8300

[sales@communicolor.com](mailto:sales@communicolor.com)

[www.communicolor.com](http://www.communicolor.com)

## Table Of Contents

3

Thermal Transfer

8

Ribbons

11

Direct Thermal

16

Sheeted Labels

22

Sheeted Cards

23

Pinfeed

26

Wafer



### Manufacturing & Distribution

#### Midwest

1855 Fox Lane  
Elgin, IL 60123

#### Southwest

9602 Dilworth Rd  
Dallas, TX 75243

#### West

211 Business Center Ct  
Redlands, CA 92373

### Distribution Center

#### East

69 Veronica Ave  
Ste 6C  
Somerset, NJ 08873

#### Southeast

1775 Breckinridge  
Pky Ste 300  
Duluth, Ga 30096



**VETERAN-OWNED  
BUSINESS**

Our nationwide distribution support centers are available  
8am to 5pm CST Monday through Friday.

# Thermal Transfer Label

Ribbons Required

3" Core • 8" OD • White Wound Out Paper Roll • Permanent Adhesive

Industrial Printer Labels

Item # Perfed	Item # Non Perfed	Label Size	Label Across	Carrier Width	Labels/ Rolls	Rolls/ Carton	Labels/ Carton	Weight
620043	620032	1-1/2 x 1	1	1-5/8	5,400	10	54,000	20.2
620000	-	1-1/2 x 1	2	3-1/4	10,800	4	43,200	21.1
620076	620054	1-5/8 x 1	1	1-3/4	5,400	10	54,000	23.0
620111	620100	2 x 1	1	2-1/8	5,500	8	44,000	22.6
620166	620155	2 x 1	2	4-1/4	11,000	4	44,000	21.3
620639	-	2 x 1-1/4	1	2-1/8	4,300	8	34,400	20.4
620087	620289	2 x 1-1/2	1	2-1/8	3,800	8	30,400	21.9
620098	620245	2 x 1-1/2	2	4-1/4	7,600	4	30,400	21.5
620122	623013	2 x 2	1	2-1/8	2,900	8	23,200	22.4
620011	-	2 x 2	2	4-1/4	5,800	4	23,200	25.0
620164	-	2 x 3	1	2-1/8	14,400	8	14,400	20.8
620144	620266	2 x 4	1	2-1/8	1,400	8	11,200	22.0
620231	-	2 x 5	1	2-1/8	1,100	8	8,800	20.8
620251	-	2-1/4 x 3/4	1	2-3/8	6,800	6	40,800	16.6
623024	620133	2-1/4 x 1-1/4	1	2-3/8	4,300	6	25,800	17.8
620416	-	2-1/4 x 2	1	2-3/8	3,500	8	28,000	24.6
620437	-	2-1/2 x 1	1	2-5/8	5,100	6	30,600	17.9
620527	-	2-1/2 x 5	1	2-5/8	1,100	6	6,600	18.7
620177	623035	3 x 1	1	3-1/8	5,500	6	33,000	24.0
620188	623046	3 x 1-1/2	1	3-1/8	3,800	6	22,800	24.9
620212	620201	3 x 2	1	3-1/8	2,900	6	17,400	24.8
623057	620256	3 x 3	1	3-1/8	1,950	6	11,700	24.8
620278	623068	3 x 4	1	3-1/8	1,430	6	8,580	24.6
620313	620302	3 x 5	1	3-1/8	1,200	6	7,200	24.9
620370	620357	3-1/2 x 1	1	3-5/8	5,500	6	33,000	28.7
623070	620403	3-1/2 x 8	1	3-5/8	750	6	4,500	29.2
620425	623081	4 x 1	1	4-1/8	5,500	4	22,000	21.5
620223	620234	4 x 1-1/2	1	4-1/8	3,500	4	14,000	24.5
620460	620458	4 x 2	1	4-1/8	2,900	4	11,600	21.9
620515	620504	4 x 2-1/2	1	4-1/8	2,350	4	9,400	22.0
620561	620550	4 x 3	1	4-1/8	1,950	4	7,800	21.9
620616	620605	4 x 4	1	4-1/8	1,500	4	6,000	22.2
620662	620651	4 x 5	1	4-1/8	1,200	4	4,800	22.1
620752	620706	4 x 6	1	4-1/8	1,000	4	4,000	22.1
620753	(Glassine Liner	4 x 6	1	4-1/8	1,000	4	4,000	22.1
620754	(Glassine Liner	4 x 6	1	4-1/8	1500	4	6,000	26.00
-	620324	4 x 6	1	4-1/8	1,250	4	5,000	22.5
620853	620807	4 x 6-1/2	1	4-1/8	900	4	3,600	21.7
620875	620886	4 x 8	1	4-1/8	750	4	3,000	22.0
623193	-	4 x 10	1	4-1/8	600	4	2,400	22.0
620930	-	4 x 12	1	4-1/8	500	4	2,000	22.0
620908	623092	4 x 13	1	4-1/8	475	4	1,900	22.0
<b>Perforated in half at 6 1/2" deep for corner wrap</b>								
-	630000	4 x 500'	1	4-1/8	1	4	4	22.2
620921	623103	4-1/2 x 2-1/2	1	4-5/8	2,350	4	9,400	23.4
620943	-	5 x 3	1	5-1/8	1,975	4	7,900	27.6
-	623114	5 x 3	1	5-1/8	1,975	4	7,900	27.6
621000	-	6 x 4	1	6-1/8	1,500	4	6,000	32.6
-	623136	6 x 4	1	6-1/8	1,500	4	6,000	32.6
623002	623147	6-1/2 x 4	1	6-5/8	1,500	4	6,000	36.0

3" Core • 8" OD • White Wound In Paper Roll • Perforated • Permanent Adhesive

Item #	Label Size	Carrier Width	Labels/ Rolls	Rolls/ Carton	Labels/ Carton	Weight
645006	4 x 3	4-1/8	1,950	4	7,800	21.8
645052	4 x 4	4-1/8	1,500	4	6,000	22.6
645107	4 x 6	4-1/8	1,000	4	4,000	22.4
645153	4 x 6-1/2	4-1/8	900	4	3,600	22.2

DON'T SEE WHAT YOU NEED? CALL 847-628-8300 OR EMAIL SALES@COMMUNICOLOR.COM FOR A CUSTOM QUOTE.

3" Core • 12" OD • Mega White Wound Out Paper Roll • Non-Perforated • Permanent Adhesive

Item #	Label Size	Carrier Width	Labels/Rolls	Rolls/Carton	Labels/Carton	Weight
623171	4 x 2	4-1/8	8,200	2	16,400	30.9
623182	4 x 3	4-1/8	5,500	2	11,000	31.1
621281	4 x 6	4-1/8	2,800	2	5,600	31.1

3" Core • 8" OD • Color Wound Out Paper Roll • Perforated • Permanent Adhesive

Item #	Label Size	Color	Carrier Width	Labels/Rolls	Rolls/Carton	Labels/Carton	Weight
640278	4 x 2	Pastel Orange • PMS 148	4-1/8	2,900	4	11,600	22.0
640300	4 x 2	Pastel Blue • PMS 290	4-1/8	2,900	4	11,600	22.0
640267	4 x 2	Pastel Pink • PMS 182	4-1/8	2,900	4	11,600	22.0
640311	4 x 2	Pastel Green • PMS 351	4-1/8	2,900	4	11,600	22.0
640245	4 x 2	Pastel Yellow • PMS 100	4-1/8	2,900	4	11,600	22.0
640322	4 x 2	Green • PMS 368	4-1/8	2,900	4	11,600	22.0
640168	4 x 2	Red • PMS 185	4-1/8	2,900	4	11,600	22.0
640289	4 x 2	Orange • PMS 021	4-1/8	2,900	4	11,600	22.0
640256	4 x 2	Pantone Yellow	4-1/8	2,900	4	11,600	22.0
640234	4 x 2	FL Pink • PMS 806	4-1/8	2,900	4	11,600	22.0
640201	4 x 2	FL Yellow • PMS 803	4-1/8	2,900	4	11,600	22.0
640190	4 x 2	FL Green • PMS 802	4-1/8	2,900	4	11,600	22.0
640212	4 x 2	FL Orange • PMS 804	4-1/8	2,900	4	11,600	22.0
640179	4 x 2	FL Blue • PMS 801	4-1/8	2,900	4	11,600	22.0
640223	4 x 2	FL Red • PMS 805	4-1/8	2,900	4	11,600	22.0

Item #	Label Size	Color	Carrier Width	Labels/Rolls	Rolls/Carton	Labels/Carton	Weight
640078	4 x 6	Pastel Orange • PMS 148	4-1/8	1,000	4	4,000	22.3
640067	4 x 6	Pastel Blue • PMS 290	4-1/8	1,000	4	4,000	22.3
640080	4 x 6	Pastel Pink • PMS 182	4-1/8	1,000	4	4,000	22.3
640056	4 x 6	Pastel Green • PMS 351	4-1/8	1,000	4	4,000	22.3
640091	4 x 6	Pastel Yellow • PMS 100	4-1/8	1,000	4	4,000	22.3
640113	4 x 6	Green • PMS 368	4-1/8	1,000	4	4,000	22.3
640146	4 x 6	Red • PMS 185	4-1/8	1,000	4	4,000	22.3
640135	4 x 6	Orange • PMS 021	4-1/8	1,000	4	4,000	22.3
610124	4 x 6	Pantone Yellow	4-1/8	1,000	4	4,000	22.3
640878	4 x 6	FL Pink • PMS 806	4-1/8	1,000	4	4,000	22.3
640900	4 x 6	FL Yellow • PMS 803	4-1/8	1,000	4	4,000	22.3
640867	4 x 6	FL Green • PMS 802	4-1/8	1,000	4	4,000	22.3
640856	4 x 6	FL Orange • PMS 804	4-1/8	1,000	4	4,000	22.3
640102	4 x 6	FL Blue • PMS 801	4-1/8	1,000	4	4,000	22.3
640889	4 x 6	FL Red • PMS 805	4-1/8	1,000	4	4,000	22.3

Item #	Label Size	Color	Carrier Width	Labels/Rolls	Rolls/Carton	Labels/Carton	Weight
640528	4 x 6-1/2	Pastel Orange • PMS 148	4-1/8	900	4	3,600	22.1
640517	4 x 6-1/2	Pastel Blue • PMS 290	4-1/8	900	4	3,600	22.1
640530	4 x 6-1/2	Pastel Pink • PMS 182	4-1/8	900	4	3,600	22.1
640506	4 x 6-1/2	Pastel Green • PMS 351	4-1/8	900	4	3,600	22.1
640541	4 x 6-1/2	Pastel Yellow • PMS 100	4-1/8	900	4	3,600	22.1
640596	4 x 6-1/2	Green • PMS 368	4-1/8	900	4	3,600	22.1
640620	4 x 6-1/2	Red • PMS 185	4-1/8	900	4	3,600	22.1
640618	4 x 6-1/2	Orange • PMS 021	4-1/8	900	4	3,600	22.1
640607	4 x 6-1/2	Pantone Yellow	4-1/8	900	4	3,600	22.1
610062	4 x 6-1/2	FL Pink • PMS 806	4-1/8	900	4	3,600	22.1
610040	4 x 6-1/2	FL Yellow • PMS 803	4-1/8	900	4	3,600	22.1
610051	4 x 6-1/2	FL Green • PMS 802	4-1/8	900	4	3,600	22.1
610018	4 x 6-1/2	FL Orange • PMS 804	4-1/8	900	4	3,600	22.1
640585	4 x 6-1/2	FL Blue • PMS 801	4-1/8	900	4	3,600	22.1
610029	4 x 6-1/2	FL Red • PMS 805	4-1/8	900	4	3,600	22.1

# Thermal Transfer

Ribbons Required

## 1" Core • 4" OD • White Wound Out Paper Roll • Perforated • Permanent Adhesive

Item #	Label Size	Labels Across	Carrier Width	Rolls/ Carton	Labels/ Roll	Labels/ Carton	Weight
660000	1 1/2 X 1	1	1 5/8	4	1,310	5,240	6.2
660001	2 X 1	1	2 1/8	4	1,400	5,600	6.2
660002	2 1/4 X 3/4	1	2 3/8	4	1,780	7,120	6.2
660003	2 1/4 X 1 1/4	1	2 3/8	4	1,135	4,540	6.2
660004	3 X 3	1	3 1/8	4	500	2,000	6.2
660005	3 1/2 X 1	1	3 5/8	4	1,310	5,240	6.2
660006	4 X 1	1	4 1/8	4	1,310	5,240	6.2
660007	4 X 1 1/2	1	4 1/8	4	960	3,840	6.2
660008	4 X 2	1	4 1/8	4	730	2,920	6.2
660009	4 X 4	1	4 1/8	4	375	1,500	6.2
660010	4 X 6	1	4 1/8	4	250	1,000	6.2

## 1" Core • 5" OD • White Wound Out Paper Roll • Perforated • Permanent Adhesive

Item #	Label Size	Labels Across	Carrier Width	Rolls/ Carton	Labels/ Roll	Labels/ Carton	Weight
650000	4 X 6	1	4 1/8	4	450	1,800	7.1
650001	4 X 4	1	4 1/8	4	700	2,800	7.1
650002	4 X 3	1	4 1/8	4	850	3,400	7.1
650003	4 X 2	1	4 1/8	4	1,250	5,000	7.1
650004	4 X 1	1	4 1/8	4	2,300	9,200	7.1
650005	3 1/2 X 1	1	3 5/8	4	2,300	9,200	7.1
650006	3 X 3	1	3 1/8	4	850	3,400	7.1
650007	3 X 2	1	3 1/8	4	1,240	4,960	7.1
650008	2 1/4 X 4	1	2 3/8	4	700	2,800	7.1
650009	2 1/4 X 1 1/4	1	2 3/8	4	1,900	7,600	7.1
650010	2 1/4 X 3/4	1	2 3/8	4	3,000	12,000	7.1
650011	2 X 1	1	2 1/8	4	2,300	9,200	7.1
650012	1 1/2 X 1	1	1 5/8	4	2,300	9,200	7.1
650013	1 1/4 X 1	1	1 3/8	4	2,300	9,200	7.1

## 3" Core • 8" OD • White 7pt Wound Out Tag Roll • Perforated • No Adhesive • C1S • Timing Notches

Item #	Label Size	Carrier Width	Tags/ Rolls	Rolls/ Carton	Tags/ Carton	Weight
621033	4 x 3	4	1,310	4	5,240	13.2
621011	4 x 6	4	800	4	3,200	13.2
621022	4 x 6 1/2	4	605	4	2,420	13.2

## Fanfold White Paper Labels • Perforated • Permanent Adhesive

Item #	Label Size	Labels Across	Carrier Width	Fold Depth	Labels/ Stack	Stacks/ Carton	Labels/ Carton	Weight
670206	2 x 1	2	4-1/4	12-3/8	20,900	2	41,800	20.2
670353	3 x 1	1	3-1/8	12-3/8	10,450	2	20,900	15.4
670454	3 x 1-1/2	1	3-1/8	13	7,280	2	14,560	15.1
670487	3 x 2	1	3-1/8	12-3/4	5,580	2	11,160	15.9
670555	3 x 5	1	3-1/8	10-1/4	2,300	2	4,600	15.7
670656	3-1/2 x 1	1	3-5/8	12-3/8	10,450	2	20,900	17.6
670757	3-1/2 x 8	1	3-5/8	8-1/8	970	3	2,910	18.4
670803	4 x 1	1	4-1/8	12-3/8	10,450	2	20,900	20.2
670050	4 x 2	1	4-1/8	12-3/4	6,000	1	6,000	10.1
670858	4 x 2-1/2	1	4-1/8	10-1/2	4,500	2	9,000	20.5
670072	4 x 3	1	4-1/8	12-1/2	3,776	1	3,776	10.7
670904	4 x 4	1	4-1/8	12-3/8	2,850	2	5,700	20.6
670948	4 x 5	1	4-1/8	10-1/4	2,300	2	4,600	21.0
670004	4 x 6	1	4-1/8	12-1/4	2,000	2	4,000	21.5
672118	4 x 6	1	4-1/8	12-1/4	4,000	1	4,000	22.1
670015	4 x 6	1	4-1/8	12-1/4	2,500	2	5,000	23.5
670105	4 x 6-1/2	1	4-1/8	13-1/4	2,000	2	4,000	23.4
671005	4 x 8	1	4-1/8	8-1/8	970	3	2,910	16.8
671152	5 x 3	1	5-1/8	12-1/2	3,800	2	7,600	26.2
672006	6 x 4	1	6-1/8	12-3/8	2,500	1	2,500	13.9

DON'T SEE WHAT YOU NEED? CALL 847-628-8300 OR EMAIL SALES@COMMUNICOLOR.COM FOR A CUSTOM QUOTE.

# Thermal Transfer

Ribbons Required

Fanfold Color Tinted Paper Labels • Perforated • Permanent Adhesive • Folded @ 12 - 1/4"

Item #	Label Size	Color	Carrier Width	Label/ Stack	Stacks/ Carton	Labels/ Carton	Weight
640421	4 x 6	Pastel Orange • PMS 148	4-1/8	2,000	2	4,000	26.0
640344	4 x 6	Pastel Blue • PMS 290	4-1/8	2,000	2	4,000	26.0
640333	4 x 6	Pastel Pink • PMS 182	4-1/8	2,000	2	4,000	26.0
640366	4 x 6	Pastel Green • PMS 351	4-1/8	2,000	2	4,000	26.0
640355	4 x 6	Pastel Yellow • PMS 100	4-1/8	2,000	2	4,000	26.0
640410	4 x 6	Green • PMS 368	4-1/8	2,000	2	4,000	26.0
640377	4 x 6	Red • PMS 185	4-1/8	2,000	2	4,000	26.0
640399	4 x 6	Orange • PMS 021	4-1/8	2,000	2	4,000	26.0
640388	4 x 6	Pantone Yellow	4-1/8	2,000	2	4,000	26.0
640443	4 x 6	FL Pink • PMS 806	4-1/8	2,000	2	4,000	26.0
640465	4 x 6	FL Yellow • PMS 803	4-1/8	2,000	2	4,000	26.0
640476	4 x 6	FL Green • PMS 802	4-1/8	2,000	2	4,000	26.0
640631	4 x 6	FL Orange • PMS 804	4-1/8	2,000	2	4,000	26.0
640454	4 x 6	FL Blue • PMS 801	4-1/8	2,000	2	4,000	26.0
640432	4 x 6	FL Red • PMS 805	4-1/8	2,000	2	4,000	26.0

## Thermal Transfer Specialty Labels

3" Core • 8" OD • Weather Resistant Wound Out Rolls • Perforated • Permanent Adhesive

Gloss White Polyester Film

Gloss White Polyester Film features a topcoat for high performance thermal transfer printing. It is recommended that durable black resin ribbons be used with this material for optimum durability. Made of an emulsion acrylic, the adhesive works well on a variety of surfaces.

Item #	Label Size	Carrier Width	Labels/ Roll	Rolls/ Carton	Labels/ Carton	Weight
649506	1-1/2 x 1/2	1-5/8	9,400	6	56,400	14.4
649517	2 x 1	2-1/8	5,500	8	44,000	27.7
649528	3 x 1	3-1/8	5,500	6	33,000	30.5
649530	4 x 1	4-1/8	5,500	4	22,000	27.3
649541	4 x 2	4-1/8	2,900	4	11,600	27.6
649552	4 x 6	4-1/8	1,000	4	4,000	28.0

3.0 mil Polypro Comparable to Kimdura® • Perforated

This material is tear resistant, and water resistance when applied to a non-porous surface. Acrylic based adhesive offers superior ultra violet (UV) resistance.

Item #	Label Size	Carrier Width	Labels/ Roll	Rolls/ Carton	Labels/ Carton	Weight
649315	4 x 2	4-1/8	2,600	4	10,400	23.4
649326	4 x 6	4-1/8	900	4	3,600	23.4

3" Core • 8" OD • Special Adhesive Wound Out Rolls • Perforated

Removable White Paper

Matte-coated, ultra-smooth surface that is tailored specifically for thermal transfer printing. The acrylic based adhesive adheres well to rough surfaces and can be easily removed even after a lengthy period of time.

Item #	Label Size	Carrier Width	Labels/ Roll	Rolls/ Carton	Labels/ Carton	Weight
642508	4 x 6	4-1/8	1,000	4	4,000	23.0
642600	4 x 6-1/2	4-1/8	900	4	3,600	23.0

Aggressive Adhesive White Paper • Permanent Adhesive

Rubber based adhesive designed for applications that require high-tack. Label offers ultimate adhesion to many substrates, especially corrugated paper.

Item # Perfed	Item # Non- Perfed	Label Size	Carrier Width	Labels/ Roll	Rolls/ Carton	Labels/ Carton	Weight
640702	640691	4 x 2	4-1/8	2,900	4	11,600	21.6
640746	640735	4 x 4	4-1/8	1,500	4	6,000	21.6
640779	640768	4 x 6	4-1/8	1,000	4	4,000	21.0

Fanfold Aggressive Adhesive White Paper • Permanent Adhesive

Item #	Label Size	Carrier Width	Fold Depth	Labels/ Stack	Stacks/ Carton	Labels/ Carton	Weight
640757	4 X 6	4-18	12-1/4	2,000	2	4,000	21.6

# THERMAL TRANSFER RIBBONS



High-quality thermal transfer ribbons offer several advantages in industrial and commercial printing applications. One key benefit is their superior print durability. The printed labels resist smudging, fading, and abrasion, making them ideal for environments where labels are exposed to harsh conditions such as chemicals, moisture, or extreme temperatures. This durability ensures long-lasting and clear readability, which is crucial for barcode scanning, product tracking, and inventory management.

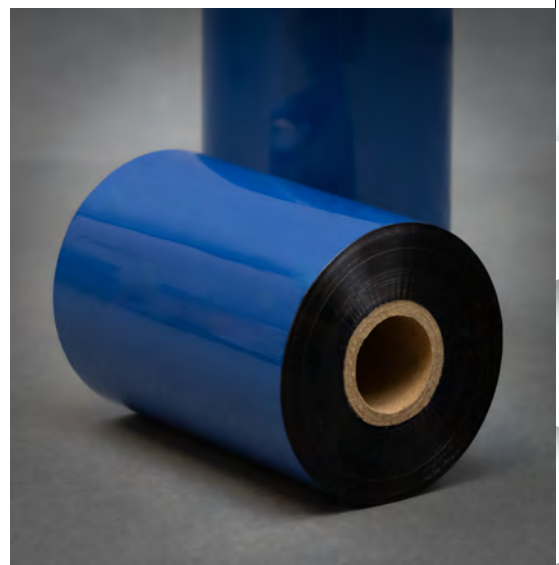

Another advantage is their versatility. High-quality thermal transfer ribbons are compatible with a wide range of label materials, including paper, polyester, and synthetic films. This adaptability makes them suitable for various applications, from shipping and logistics to retail and healthcare. The ribbons also provide sharp, high-contrast prints that enhance readability and professional appearance, improving overall product presentation and operational efficiency. Communicolor offers a full range of standard and custom ribbons to fit your every need. Our knowledgeable staff is always available to help with technical support to insure you get the right ribbon for your application.



# Ribbons Reference Guide

	Wax	Wax Resin	Near Edge Wax	Resin
<b>Tags</b>				
Uncoated Tags	•	•	•	
Coated Tags	•	•	•	•
<b>Paper Label Stocks</b>				
Coated Face Stocks	•	•	•	•
Uncoated Face Stocks	•	•	•	
Tinted Face Sheets	•	•	•	•
Gloss Sheets	•	•	•	
<b>Synthetics</b>				
Polypropylene (Matte Top Coat)	•	•	•	•
Polypropylene (Gloss)		•	•	•
Vinyl (Top Coat)		•	•	•
Polyethylene Bags		•	•	•
Polystyrene		•	•	•
Polyolefin	•	•	•	•
<b>Other Synthetics</b>				
Polyester (Gloss Top Coat)				•
Polyester (Matte Top Coat)		•	•	•
<b>Other Synthetics</b>				
Tyvek ®	•	•	•	•
Tyvek Brillion ®	•	•	•	•
Valeron ®	•	•	•	•
Polyimide ®				•
PVC Shrink Wrap ®		•	•	•

**Wax**- Wide media performance. For coated papers, matte synthetics, and poly bags. Excellent durability.

**Wax Resin**- Wide print range. For paper, polypropylene, and polyester.

**Near Edge Wax**- High and low speed printer performance. For data coding and bar-coding, film and paper.

**Resin**- Wide substrate range. General purpose Resin. Excellent durability with low print energy.



## Cleaning Cards for Thermal Printers

Designed to clean performance-critical surfaces inside thermal printer devices, our results shown to improve print quality while significantly reducing media jamming and unnecessary device downtime.

\*\*\*Minimum Order Quantity 4 Cartons

Item Number	Card Size	Cards/ Carton	Carton Weight lbs
84086	2" x 6"	25	1
84087	4" x 6"	25	1



Sold by the Individual Ribbon

## Ribbons

Wax

Datamax ®	Item Number	Ribbon Size	Ribbon Size Metric	Ribbon Weight
	710700	2.52" x 1181'	64mm x 360m	1
	710357	2.99" x 1181'	76mm x 360m	1
	710702	3.54" x 1181'	90mm x 360m	1
	710403	4.02" x 1181'	102mm x 360m	1
	710458	4.33" x 1181'	110mm x 360m	1
<b>Sato ®</b>				
	710706	4.33" x 1345'	110mm x 410m	1
<b>Intermac ®</b>				
	710504	4.09" x 509'	104mm x 155m	1
<b>Zebra ®</b>				
	710008	2.36" x 984'	60mm x 300m	1
	710054	3.15" x 984'	80mm x 300m	1
	710708	3.15" x 1476'	80mm x 450m	1
	710710	3.27" x 1476'	83mm x 450m	1
	710712	4.02" x 1476'	102mm x 450m	1
	710718	4.33" x 243'	110mm x 74m	1
	710155	4.33" x 984'	110mm x 300m	1
	710166	4.33" x 1476'	110mm x 450m	1
	710714	5.12" x 1476'	130mm x 450m	2
	710716	6.5" x 1476'	165mm x 450m	2
<b>General Purpose</b>	750291	4.33" x 1467"	1100mm x 450m	1

# Ribbons

Wax W100P

Sold by the Carton (Custom Order)

Item Number	Ribbon Size	Ribbon Size Metric	Ribbons/ Carton	Carton Weight lbs
<b>Datamax ®</b>				
730106	4.02" x 1476'	102mm x 450m	24	25
730108	4.33" x 1476'	110mm x 450m	24	26
<b>Monarch ® 9800</b>				
730110	4.33" x 1969'	110mm x 600m	12	18
<b>Printronic ®</b>				
730111	4.33" x 2051'	110mm x 625m	12	18
<b>Zebra ®</b>				
730115	2.36" x 1476'	60mm x 450m	36	22
730128	4.02" x 984'	102mm x 300m	24	25
730125	4.33" x 2953'	110mm x 900m	24	27
730127	8.66" x 1476'	220mm x 450m	12	27

Performance Resin Enhance Wax Color W100C

Sold by the Carton (Custom Order)

Item Number	Ribbon Size	Ribbon Size Metric	Color	Ribbons/ Carton	Carton Weight lbs
<b>Datamax ®</b>					
730104	4.02" x 1181'	102mm x 360m	Red PMS 185C	24	23
730102	4.02" x 1181'	102mm x 360m	Blue PMS 2728C	24	23
730103	4.02" x 1181'	102mm x 360m	Green PMS 334C	24	23
<b>Zebra ®</b>					
730120	4.33" x 984'	110mm x 300m	Red PMS 185C	24	20
730118	4.33" x 984'	110mm x 300m	Blue PMS 2728C	24	20
730119	4.33" x 984'	110mm x 300m	Green PMS 334C	24	20

Wax Resin R400

Sold by the Carton (Custom Order)

Item Number	Ribbon Size	Ribbon Size Metric	Ribbons/ Carton	Carton Weight lbs
<b>Zebra ®</b>				
730121	4.33" x 984'	110mm x 300m	24	18
730123	4.33" x 1476'	110mm x 450m	24	28

Wax Resin R600

Sold by the Carton (Custom Order)

Item Number	Ribbon Size	Ribbon Size Metric	Ribbons/ Carton	Carton Weight lbs
<b>Datamax ®</b>				
730100	2.09" x 1181'	53mm x 360m	24	12
730101	2.99" x 1181'	76mm x 360m	24	17
730105	4.02" x 1181'	102mm x 360m	24	18
730107	4.33" x 1181'	110mm x 360m	24	20
730109	5.98" x 1181'	152mm x 360m	12	13
<b>Zebra ®</b>				
730116	2.52" x 984'	64mm x 300m	24	12
730117	3.15" x 984'	80mm x 300m	24	15
730122	4.33" x 984'	110mm x 300m	24	18
730124	4.33" x 1476'	110mm x 450m	24	24
730126	5.98" x 984'	152mm x 300m	12	14

Near Edge Wax WR400NE

Sold by the Carton (Custom Order)

Item Number	Ribbon Size	Ribbon Size Metric	Ribbons/ Carton	Carton Weight lbs
<b>Avery ®, Novexx ®</b>				
730112	4.33" x 1969'	110mm x 600m	12	19
<b>Toshiba ®</b>				
730113	4.17" x 1969'	106mm x 600m	12	18
730114	5.16" x 1969'	131mm x 600m	12	22

# Fast, On Demand Color Label Printing without Compromise.

DESKTOP COLOR LABEL PRINTER

## VP750

The VP750 color label printer is ideal for short to medium print requirements. Combined with its ability to print vibrant colors at up to 60 feet per minute on a wide range of paper, polyester, polypropylene and vinyl label stocks makes the VP750 the perfect solution for printing labels in-house, on time and on your terms.



### High speed

Fast print speed up to 12 inches per second. Prints up to 2,400 4" x 3" labels within 10 minutes.



### Dynamic color

Brilliant colors for prime labels with resolutions up to 1,600 x 1,600 dpi. Great for crisp text and fine barcodes.



### More labels per ink change

Individual 250ml ink tanks reduce replacement cost.



### Perfect for short runs

Print from 1 up to 10,000 labels anytime on demand.



### Large label printer

Prints labels up to 8.5" wide, offering the flexibility to produce everything from high-quality food labels to durable carton box labels.



### Dust-free enclosure

With a metal enclosure to keep dust out, the VP750 is tough enough to weather 24/7 operations on a dusty factory floor.



## Food Safe

VIP Color label printers use non-toxic aqueous dye inks, making them a safe choice for producing labels used in indirect food contact applications. It's a smart, reliable way to create vibrant, high-quality labels while maintaining safety for food packaging.

## Water Resistant Labels

VP750 labels deliver excellent water resistance compared to other dye inks, helping your labels stay bright and vibrant even when exposed to moisture. They maintain their brilliance and vivid color through contact with water and even some solvents like alcohol. Ideal for craft beer, wine, water bottles, and frozen foods.



DON'T SEE WHAT YOU NEED? CALL 847-628-8300 OR EMAIL SALES@COMMUNICOLOR.COM FOR A CUSTOM QUOTE.

# Direct Thermal Labels

Mobile Printer Labels

3/4" Core • 2.4" OD • Wound Out Paper Roll • Perforated • Permanent Adhesive • With and Without Timing Mark

Compatible with Zebra® and Datamax® Mobile Printers

Item #	Label Size	With Top Coat	With Timing Marks	Carrier Width	Labels/Rolls	Rolls/Carton	Labels/Carton	Weight
510669	2 x 1-1/4	•	•	2-1/8	280	24	6,720	5
510671	2 x 1-1/4		•	2-1/8	280	24	6,720	5
510670	2 x 1-1/4	•		2-1/8	280	24	6,720	5
510672	2 x 1-1/4			2-1/8	280	24	6,720	5
510691	2 x 2	•	•	2-1/8	300	24	7,200	7.5
510693	2 x 2		•	2-1/8	300	24	7,200	7.5
510692	2 x 2	•		2-1/8	300	24	7,200	7.5
510694	2 x 2			2-1/8	300	24	7,200	7.5
510702	3 x 1	•	•	3-1/8	550	24	13,200	11
510704	3 x 1		•	3-1/8	550	24	13,200	11
510703	3 x 1	•		3-1/8	550	24	13,200	11
510705	3 x 1			3-1/8	550	24	13,200	11
510713	3 x 2	•	•	3-1/8	300	24	7,200	12
510715	3 x 2		•	3-1/8	300	24	7,200	12
510714	3 x 2	•		3-1/8	300	24	7,200	12
510716	3 x 2			3-1/8	300	24	7,200	12
510636	4 x 2	•	•	4-1/8	300	24	7,200	15
510638	4 x 2		•	4-1/8	300	24	7,200	15
510637	4 x 2	•		4-1/8	300	24	7,200	15
510539	4 x 2			4-1/8	300	24	7,200	15
510724	4 x 3	•	•	4-1/8	200	24	4,800	15
510726	4 x 3		•	4-1/8	200	24	4,800	15
510725	4 x 3	•		4-1/8	200	24	4,800	15
510727	4 x 3			4-1/8	200	24	4,800	15
510746	4 x 4	•	•	4-1/8	150	24	3,600	15
210748	4 x 4		•	4-1/8	150	24	3,600	15
510747	4 x 4	•		4-1/8	150	24	3,600	15
510749	4 x 4			4-1/8	150	24	3,600	15
510658	4 x 6	•	•	4-1/8	105	24	2,520	15.5
510661	4 x 6		•	4-1/8	105	24	2,520	15.5
510659	4 x 6	•		4-1/8	105	24	2,520	15.5
510662	4 x 6			4-1/8	105	24	2,520	15.5

## Desktop Printer Labels

1" Core • 4" OD • White Wound • Out Paper Roll • Perforated • Permanent Adhesive

Item #	Label Size	With Top Coat	Carrier Width	Labels/Rolls	Rolls/Carton	Labels/Carton	Weight
530211	1 x 1/2	•	1-1/4	2,400	12	28,800	4.1
530515	1 x 3	•	1-1/8	500	12	6,000	5.3
530517	1 x 3		1-1/8	500	12	6,000	5.3
530526	1-1/5 x 17/20	•	1.325	1,500	12	18,000	5.3
530527	1-1/5 x 17/20		1.325	1,500	12	18,000	5.3
530537	1-1/4 x 1	•	1-3/8	1,300	12	15,600	5.3
530538	1-1/4 x 1		1-3/8	1,300	12	15,600	5.3
530548	1-1/2 x 1	•	1-5/8	1,300	12	15,600	6.8
530749	1-1/2 x 1		1-5/8	1,300	12	15,600	6.8
530728	1-1/2 x 1-1/2	•	1-5/8	900	12	10,800	6.5
530729	1-1/2 x 1-1/2		1-5/8	900	12	10,800	6.5
530559	1-1/2 x 3	•	1-5/8	500	12	6,000	7
530550	2 x 1	•	2-1/8	1,300	12	15,600	8.4
530551	2 x 1		2-1/8	1,300	12	15,600	8.4
530739	2 x 1-1-1/4	•	2-1/8	1,000	12	12,000	7.4
530561	2 x 1-1/2	•	2-1/8	900	12	10,800	9.1
530562	2 x 1-1/2		2-1/8	900	12	10,800	9.1
530730	2 x 2	•	2-1/8	700	12	8,400	9.0
530731	2 x 2		2-1/8	700	12	8,400	9.0

DON'T SEE WHAT YOU NEED? CALL 847-628-8300 OR EMAIL SALES@COMMUNICOLOR.COM FOR A CUSTOM QUOTE.

## Desktop Printer Labels

1" Core • 4" OD • White Wound Out Paper Roll • Perforated • Permanent Adhesive

Item #	Label Size	With Top Coat	Carrier Width	Labels/Rolls	Rolls/Carton	Labels/Carton	Weight
530830	2 x 3	•	2-1/8	500	12	6,000	9.1
530572	2 x 4	•	2-1/8	350	12	4,200	8.8
530573	2 x 4	•	2-1/8	350	12	4,200	8.8
530841	2 x 6	•	2-1/8	250	12	3,000	9
530852	2 x 200'	•	2-1/8	1	12	12	13.9
530584	2-1/4 x 3/4	•	2-3/8	1,700	12	20,400	9.3
530594	2-1/4 x 1-1/4	•	2-3/8	1,000	12	12,000	9.2
530595	2-1/4 x 1-1/4	•	2-3/8	1,000	12	12,000	9.2
530605	2-1/4 x 2	•	2-3/8	700	12	8,400	9.8
530606	2-1/4 x 2	•	2-3/8	700	12	8,400	9.8
530616	2-1/4 x 3	•	2-3/8	500	12	6,000	10.2
530617	2-1/4 x 3	•	2-3/8	500	12	6,000	10.2
530627	2-1/4 x 4	•	2-3/8	350	12	4,200	9.9
530628	2-1/4 x 4	•	2-3/8	350	12	4,200	9.9
530638	3 x 1	•	3-1/8	1,300	12	15,600	12.5
530639	3 x 1	•	3-1/8	1,300	12	15,600	12.5
530741	3 x 2	•	3-1/8	700	12	8,400	13.1
530742	3 x 2	•	3-1/8	700	12	8,400	13.1
530640	3 x 3	•	3-1/8	500	12	6,000	14.1
530641	3 x 3	•	3-1/8	500	12	6,000	14.1
530752	3 x 5	•	3-1/8	300	12	3,600	13.8
530753	3 x 5	•	3-1/8	300	12	3,600	13.8
530651	3-1/2 x 1-1/2	•	3-5/8	900	12	10,800	14.4
530652	3-1/2 x 1-1/2	•	3-5/8	900	12	10,800	14.4
530763	4 x 1	•	4-1/8	1,300	12	15,600	16.6
530764	4 x 1	•	4-1/8	1,300	12	15,600	16.6
530774	4 x 1-1/2	•	4-1/8	900	12	10,800	16.9
530775	4 x 1-1/2	•	4-1/8	900	12	10,800	16.9
530785	4 x 2	•	4-1/8	700	12	8,400	17.7
530789	4 x 2	•	4-1/8	700	12	8,400	17.7
530796	4 x 2-1/2	•	4-1/8	575	12	6,900	17.6
530797	4 x 2-1/2	•	4-1/8	575	12	6,900	17.6
530000	4 x 3	•	4-1/8	500	16	8,000	24.3
530002	4 x 3	•	4-1/8	500	16	8,000	24.3
530807	4 x 4	•	4-1/8	350	12	4,200	17.2
530808	4 x 4	•	4-1/8	350	12	4,200	17.2
530662	4 x 5	•	4-1/8	300	12	3,600	18.1
530663	4 x 5	•	4-1/8	300	12	3,600	18.1
530011	4 x 6	•	4-1/8	250	16	4,000	24.1
530012	4 x 6	•	4-1/8	250	16	4,000	24.1
530673	4 x 6-1/2	•	4-1/8	200	12	2,400	15.8
530674	4 x 6-1/2	•	4-1/8	200	12	2,400	15.8
530717	4 x 8	•	4-1/8	200	12	2,400	19.3
530718	4 x 8	•	4-1/8	200	12	2,400	19.3
510638	4 x 10	•	4-1/8	160	12	1,920	15.8
530874	4 x 200'	•	4-1/8	1	12	12	27.2

1" Core • 5" OD • White Wound Out Paper Roll • Perforated • Permanent Adhesive

Item #	Label Size	With Top Coat	Carrier Width	Labels/Rolls	Rolls/Carton	Labels/Carton	Weight
530033	4 x 6	•	4-1/8	450	4	1,800	9.8
530034	4 x 6	•	4-1/8	450	4	1,800	9.8

# Direct Thermal Labels

## 1" Core • 4" OD • White IR Scannable Top coated Wound Out Paper Roll • Permanent Adhesive

Item #	Label Size	Carrier Width	Labels/Rolls	Rolls/Carton	Labels/Carton	Weight
530695	4 x 6	4-1/8	245	12	2,940	19.8
plus 3/4" tab Non-perfed- FedEx®						
530706	4 x 6	4-1/8	185	12	2,220	18.2
plus 2" tab Perfed- UPS®						

For fast bar-code scanning with an infrared laser. Used in applications where scanning in the 675 nanometer wavelength.

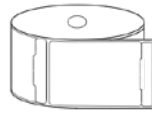

FedEx®  
530695

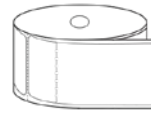

UPS®  
530706

## 3" Core • 8" OD • White Non-Top coated Wound Out Paper Roll • Permanent Adhesive

Item # Perfed	Item # Non-Perfed	Label Size	Carrier Width	Labels/Rolls	Rolls/Carton	Labels/Carton	Weight
510043	-	1-1/2 x 1	1-5/8	5,100	8	40,800	15.7
510060	-	2 x 6	2-1/8	1,000	8	8,000	23.8
510075	-	2-1/2 x 2-1/2	2-1/2	2,200	8	17,600	24.7
510100	-	3 x 3	3-1/8	1,800	8	10,800	23.6
510028	510570	3 x 5	3-1/8	1,200	6	7,200	26.1
510200	-	3-1/2 x 3-1/2	3-5/8	1,600	8	9,600	27.9
510041	510581	4 x 2	4-1/8	2,900	4	11,600	22.8
510592	510052	4 x 3	4-1/8	2,000	4	8,000	23.4
510074	510603	4 x 4	4-1/8	1,500	4	6,000	23.3
510620	-	4 x 5	4-1/8	1,100	4	4,400	20.9
510118	510107	4 x 6	4-1/8	1,000	4	4,000	23.4
510757	-	4 x 6	4-1/8	1,100	4	4,400	23.5
510513	-	4 x 6-1/2	4-1/8	900	4	3,600	23.6
	510502	4 x 6-1/2	4-1/8	900	4	3,600	23.6
510875	510886	4 x 8	4-1/8	750	4	3,000	23.6
510540	-	4-1/2 x 6-1/2	4-5/8	900	4	3,600	24.8

## 3" Core • 12" OD • White Mega Non-Top coated Wound Out Paper Roll • Non-Perforated • Permanent Adhesive

Item #	Label Size	Carrier Width	Labels/Rolls	Rolls/Carton	Labels/Carton	Weight
530818	4 x 6	4-1/8	2,800	2	5,600	32.3

## 3" Core • 8" OD • Color Non-Top coated Wound Out Paper Roll • Perforated • Permanent Adhesive

Item #	Label Size	Color	Carrier Width	Labels/Rolls	Rolls/Carton	Labels/Carton	Weight
520350	4 x 6	Pastel Orange • PMS 148	4-1/8	1,000	4	4,000	23.4
520361	4 x 6	Pastel Blue • PMS 290	4-1/8	1,000	4	4,000	23.4
520251	4 x 6	Pastel Pink • PMS 182	4-1/8	1,000	4	4,000	23.4
520372	4 x 6	Pastel Green • PMS 351	4-1/8	1,000	4	4,000	23.4
520273	4 x 6	Pastel Yellow • PMS 100	4-1/8	1,000	4	4,000	23.4
520240	4 x 6	Green • PMS 368	4-1/8	1,000	4	4,000	23.4
520262	4 x 6	Red • PMS 185	4-1/8	1,000	4	4,000	23.4
520229	4 x 6	Orange • PMS 021	4-1/8	1,000	4	4,000	23.4
520383	4 x 6	Pantone Yellow	4-1/8	1,000	4	4,000	23.4
520284	4 x 6	FL Pink • PMS 806	4-1/8	1,000	4	4,000	23.4
520317	4 x 6	FL Yellow • PMS 803	4-1/8	1,000	4	4,000	23.4
520306	4 x 6	FL Green • PMS 802	4-1/8	1,000	4	4,000	23.4
520328	4 x 6	FL Orange • PMS 804	4-1/8	1,000	4	4,000	23.4
520295	4 x 6	FL Blue • PMS 801	4-1/8	1,000	4	4,000	23.4
520339	4 x 6	FL Red • PMS 805	4-1/8	1,000	4	4,000	23.4

## 3" Core • 8" OD • White 7.5pt Top coated Wound Out Tag Roll • Perforated • No Adhesive • C1S • Timing Notches

Item #	Label Size	Tags/Roll	Rolls/Carton	Tags/Carton	Weight
521000	3 x 5	1,100	6	6,600	18
521011	4 x 3	1,800	4	7,200	18
521022	4 x 6	900	4	3,600	18

# Direct Thermal Labels

Fanfolds White Paper Non-Top coated Labels • Perforated • Permanent Adhesive

Item #	Label Size	Fold Depth	Carrier Width	Labels/ Stack	Stacks/ Carton	Labels/ Carton	Weight
520196	4 x 2	12-3/4	4-1/8	6,000	1	6,000	18.0
520207	4 x 3	12-1/2	4-1/8	3,776	1	3,776	19.0
520218	4 x 4	12-3/8	4-1/8	2,850	2	5,700	20.0
520007	4 x 6	12-1/4	4-1/8	2,000	2	4,000	22.8
520046	4 x 6	*Scuff Resistant Top coated	4-1/8	2,000	2	4,000	22.8
520048	4 X 8	8/12	4-1/8	970	3	2,910	22.8
520053	4 x 6-1/2	13-1/4	4-1/8	2,000	2	4,000	24.3

Fanfolds Color Paper Non-Top coated Labels • Perforated • Permanent Adhesive • Folded @ 12/1/4"

Item #	Label Size	Color	Carrier Width	Labels/ Stacks	Stacks/ Carton	Labels/ Carton	Weight
520174	4 x 6	Pastel Orange • PMS 148	4-1/8	2,000	2	4,000	22.8
520086	4 x 6	Pastel Blue • PMS 290	4-1/8	2,000	2	4,000	22.8
520097	4 x 6	Pastel Pink • PMS 182	4-1/8	2,000	2	4,000	22.8
520108	4 x 6	Pastel Green • PMS 351	4-1/8	2,000	2	4,000	22.8
520119	4 x 6	Pastel Yellow • PMS 100	4-1/8	2,000	2	4,000	22.8
520130	4 x 6	Green • PMS 368	4-1/8	2,000	2	4,000	22.8
520163	4 x 6	Red • PMS 185	4-1/8	2,000	2	4,000	22.8
520141	4 x 6	Orange • PMS 021	4-1/8	2,000	2	4,000	22.8
520152	4 x 6	Pantone Yellow	4-1/8	2,000	2	4,000	22.8
520075	4 x 6	FL Pink • PMS 806	4-1/8	2,000	2	4,000	22.8
520029	4 x 6	FL Yellow • PMS 803	4-1/8	2,000	2	4,000	22.8
520018	4 x 6	FL Green • PMS 802	4-1/8	2,000	2	4,000	22.8
520040	4 x 6	FL Orange • PMS 804	4-1/8	2,000	2	4,000	22.8
520185	4 x 6	FL Blue • PMS 801	4-1/8	2,000	2	4,000	22.8
520064	4 x 6	FL Red • PMS 805	4-1/8	2,000	2	4,000	22.8

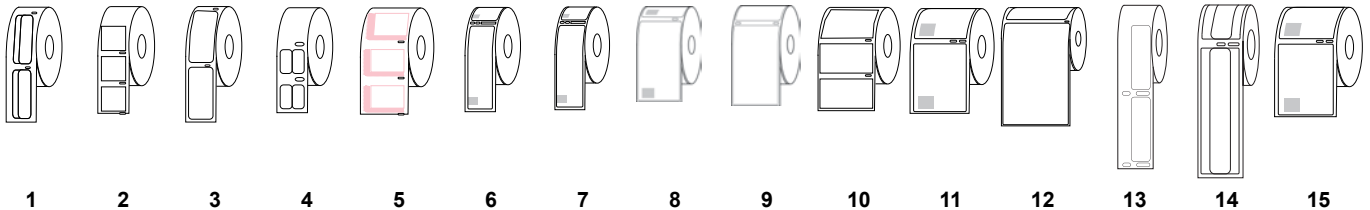

1" Core • Top coated Wound Out Paper Roll • Timing Punch • Permanent Adhesive

Image #	Item #	Label Size	Description	Dymo® Part #	Labels/ Roll	Rolls/ Carton	Labels/ Carton	Weight
<b>Dymo® Compatible</b>								
1	530842	3/4 x 2	Return Address	30330	500	10	5,000	3.8
2	530853	1 x 1	Multipurpose	30332	750	10	7,500	3.3
3	530864	1 x 2-1/8	Multipurpose	30336	500	6	3,000	2.4
4	530820	1/2 x 1	2-Up Multipurpose	30333	1,000	6	6,000	1.8
5	530875	1-5/8 x 1-1/4	Postage w/ Pink Boarder	30915	200	12	2,400	2.3
6	530403	1-1/8 x 3-1/2	Address	30251	130	12	1,560	2.2
6	550056	1-1/8 x 3-1/2	Jumbo Address	30320	260	12	3,120	3.7
6	530357	1-1/8 x 3-1/2	Mega Address	30252	350	12	4,200	4.7
6	530425	1-1/8 x 3-1/2	Clear Address	30254	130	12	1,560	2.3
7	530886	1-2/5 x 3-1/2	Larger Address	30321	260	12	3,120	3.5
8	550157	2-1/8 x 4	Shipping	30323	220	6	1,320	3.4
9	530201	2-5/16 x 4	Shipping	30256	300	6	1,800	4.6
10	530897	2-1/4 x 1-1/4	Identification	30334	1,000	6	6,000	5.3
11	530155	2-1/8 x 2-3/4	Disk	30258	400	6	2,400	4.3
12	530516	4-1/8 x 6-1/4	Shipping	1744907	220	6	1,320	9.0
13	530178	1/2 x 1-7/8	Multipurpose	30346	600	6	3,600	1.8
14	530189	9/16 x 3-7/16	Multipurpose	30277	130	20	2,600	3.4
<b>Seiko® Compatible</b>								
15	550102	2-1/8 x 2-3/4	Name Badge		320	6	1,920	3.5

Compatible with Dymo® (not compatible with 500 series printers) Labelwriter®, Seiko® Printers.

# CUSTOM LABELS

Barcodes, warning labels and tags. Your labels the way you need them. High-quality, durable, and perfectly aligned with your brand. From small batches to large-scale runs, our custom labels meet the needs of industries like manufacturing, retail, and logistics. Whether for products, inventory, or compliance, our labels offer the flexibility and reliability your business demands while enhancing professionalism.

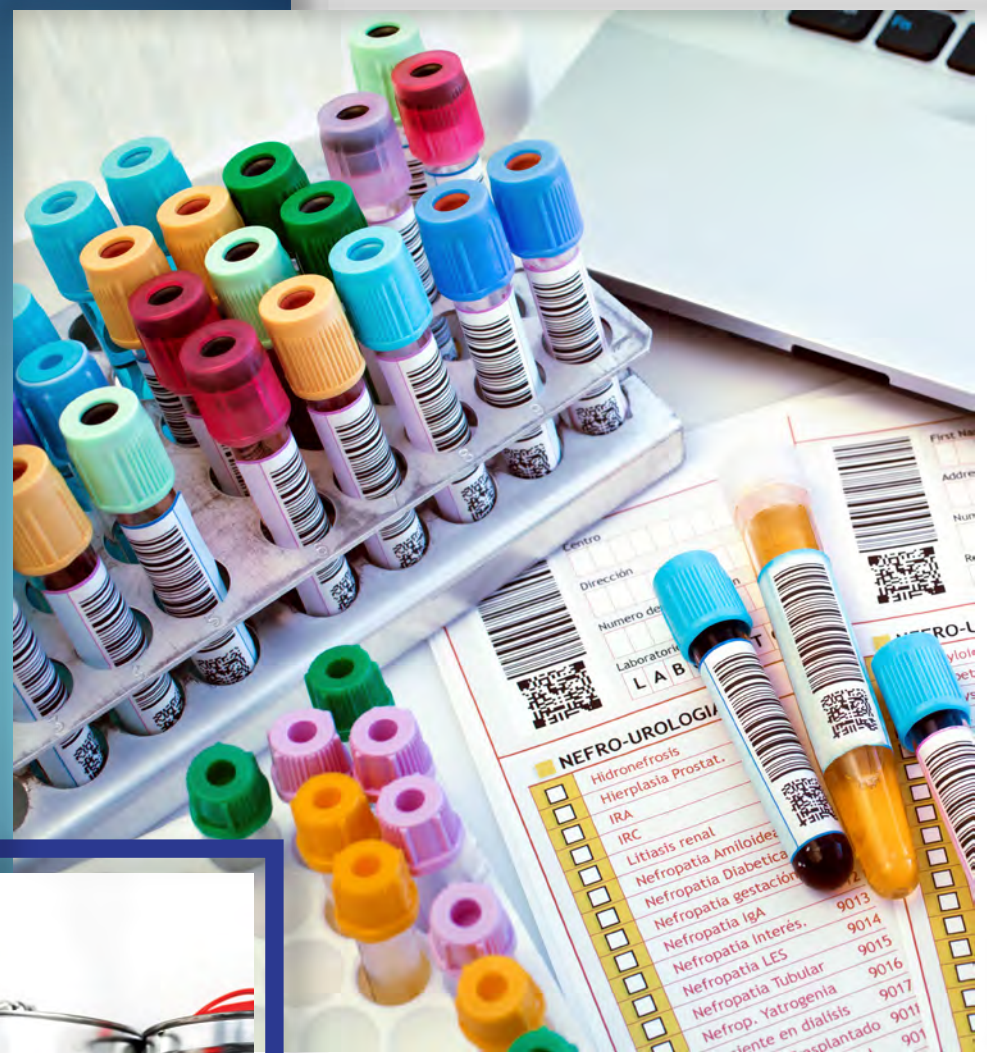

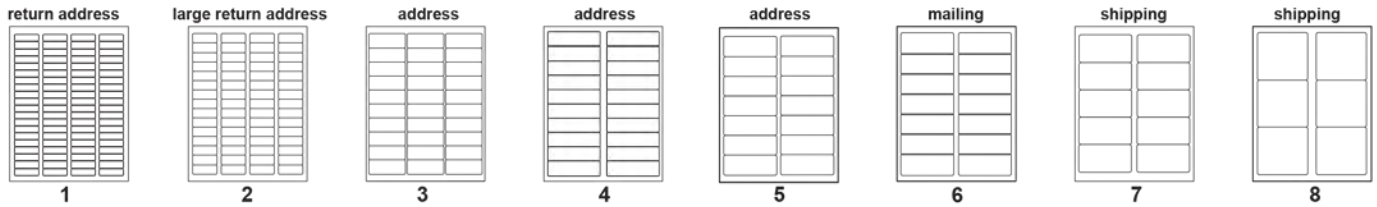

Standard White 50lbs Paper • Permanent Adhesive • Inkjet, Laser, Color Printers, Copiers

Image #	Item # 100 Sht	Item # 250 Sht	Item # 1,000 Sht	Label Size	Label Across	Labels Down	Labels/ Sht	Labels/ 100 Ctn	Labels/ 250 Ctn	Labels/ 1,000 Ctn			
1	310735	331233	340749	1-3/4 x 1/2	4	20	80	8,000	20,000	80,000			
2	310689	331312	345770	1-3/4 x 2/3	4	15	60	6,000	15,000	60,000			
3	310724	331266	340110	2-5/8 x 1	3	10	30	3,000	7,500	30,000			
4	311174	331424	340771	4 x 1	2	10	20	2,000	5,000	20,000			
5	310790	331435	345781	4 x 1-1/3	2	7	14	1,400	3,500	14,000			
6	310814	331288	345616	4 x 1-1/2	2	7	14	1,400	3,500	14,000			
7	310746	331277	340760	4 x 2	2	5	10	1,000	2,500	10,000			
8	310779	331244	340266	4 x 3-1/3	2	3	6	600	1,500	6,000			
8	*310780	*331245	*340267	4 x 3-1/3	2	3	6	600	1,500	6,000			
*Non-Perforated								Approximate weight for the above products			2.6 lbs	6 lbs	25 lbs

Standard White 50lbs Paper • Removable Adhesive • Inkjet, Laser, Color Printers, Copiers

Image #	Item # 100 Sht	Item # 250 Sht	Item # 1,000 Sht	Label Size	Label Across	Labels Down	Labels/ Sht	Labels/ 100 Ctn	Labels/ 250 Ctn	Labels/ 1,000 Ctn			
3	310961	331334	345748	2-5/8 x 1	3	10	30	3,000	7,500	30,000			
7	310972	331345	345759	4 x 2	2	5	10	1,000	2,500	10,000			
								Approximate weight for the above products			2.6 lbs	6 lbs	25 lbs

White Cover Up Paper • Permanent Adhesive • Inkjet, Laser, Color Printers

Image #	Item # 100 Sht	Item # 250 Sht	Item # 1,000 Sht	Label Size	Label Across	Labels Down	Labels/ Sht	Labels/ 100 Ctn	Labels/ 250 Ctn	Labels/ 1,000 Ctn			
7	371077	331637	345902	4 x 2	2	5	10	1,000	2,500	10,000			
8	371066	331672	345891	4 x 3-1/3	2	3	6	600	1,500	6,000			
								Approximate weight for the above products			2.6 lbs	6 lbs	25 lbs

Weather Resistant Polyester • Permanent Adhesive • Laser Printer Only

Image #	Item # 100 Sht	Item # 250 Sht	Item # 1,000 Sht	Label Size	Label Across	Labels Down	Labels/ Sht	Labels/ 100 Ctn	Labels/ 250 Ctn	Labels/ 1,000 Ctn			
1	371112	-	--	1-3/4 x 1/2	4	20	80	1,100	-	-			
3	371022	331536	345858	2-5/8 x 1	3	10	30	3,000	7,500	30,000			
5	371044	331547	345847	4 x 1-1/3	2	7	14	1,400	3,500	14,000			
7	371002	331582	345836	4 x 2	2	5	10	1,000	2,500	10,000			
8	371033	331593	345825	4 x 3-1/3	2	3	6	600	1,500	6,000			
								Approximate weight for the above products			2.6 lbs	6 lbs	25 lbs

Magnet Sheets • 25 Sheets per Carton • Inkjet Printer Only • Non-Adhesive • Inkjet, Laser, Color Printers, Copiers

Item #	Label Size	Sheets/ Ctn
360420	8-1/2 x 11	25
Approximate weight for the above products		3.1 lbs

# Traditional Sheeted Labels (non FABTab™)

8-1/2" x 11" Sheet

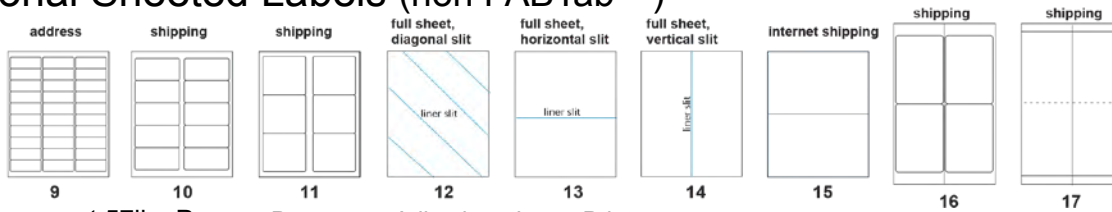

## Bright Fluorescent 57lbs Paper • Permanent Adhesive • Laser Printer

Image #	Item # 100 Sht	Item # 250 Sht	Item # 1,000 Sht	Label Size	Color	Labels Across	Labels Down	Labels/ Sht	Labels/ 100 Ctn	Labels/ 250 Ctn	Labels/ 1,000 Ctn
9	311152	330333	340088	2-5/8 x 1	FL Yellow	3	10	30	3,000	7,500	30,000
9	311051	330287	340066	2-5/8 x 1	FL Pink	3	10	30	3,000	7,500	30,000
9	311005	330276	340099	2-5/8 x 1	FL Green	3	10	30	3,000	7,500	30,000
9	311207	330311	340121	2-5/8 x 1	FL Orange	3	10	30	3,000	7,500	30,000
9	311106	330322	340077	2-5/8 x 1	FL Red	3	10	30	3,000	7,500	30,000
10	312186	331187	340044	4 x 2	FL Yellow	2	5	10	1,000	2,500	10,000
10	312164	331211	340022	4 x 2	FL Pink	2	5	10	1,000	2,500	10,000
10	312142	331222	340011	4 x 2	FL Green	2	5	10	1,000	2,500	10,000
10	312197	331176	340055	4 x 2	FL Orange	2	5	10	1,000	2,500	10,000
10	312175	331165	340033	4 x 2	FL Red	2	5	10	1,000	2,500	10,000
11	312401	331119	340198	4 x 3-1/3	FL Yellow	2	3	6	600	1,500	6,000
11	312300	331130	340187	4 x 3-1/3	FL Pink	2	3	6	600	1,500	6,000
11	312254	331141	340143	4 x 3-1/3	FL Green	2	3	6	600	1,500	6,000
11	312456	331097	340132	4 x 3-1/3	FL Orange	2	3	6	600	1,500	6,000
11	312355	331086	340176	4 x 3-1/3	FL Red	2	3	6	600	1,500	6,000
15	318600	318611	318622	8-1/2 x 5-1/2	FL Yellow	1	2	2	200	500	2,000
12	313255	-	340253	8-1/2 x 11	FL Yellow	1	1	1	100	-	1,000
12	313154	-	340242	8-1/2 x 11	FL Pink	1	1	1	100	-	1,000
12	313108	-	340220	8-1/2 x 11	FL Green	1	1	1	100	-	1,000
12	313301	-	340209	8-1/2 x 11	FL Orange	1	1	1	100	-	1,000
12	313200	-	340231	8-1/2 x 11	FL Red	1	1	1	100	-	1,000
Approximate weight for the above products									2.7 lbs	6.5 lbs	25.6 lbs

## Standard White 50lbs Paper • Permanent Adhesive • Inkjet, Laser, Color Printer, Copiers

Image #	Item # 100 Sht	Item # 250 Sht	Item # 1,000 Sht	Label Size	Label Across	Labels Down	Label/ Sht	Labels/ 100 Ctn	Labels/ 250 Ctn	Labels/ 1,000 Ctn	
15	313402	332201	340301	8-1/2 x 5-1/2	1	2	2	200	500	2,000	
12	313053	332100	318655	8-1/2 x 11	1	1	1	100	250	1,000	
13	313356	332155	318633	8-1/2 x 11	1	1	1	100	250	1,000	
14	318587	318598	318644	8-1/2 x 11	1	1	1	100	250	1,000	
Approximate weight for the above products									2.1 lbs	5.2 lbs	20 lbs

## White Cover Up Paper • Permanent Adhesive • Inkjet, Laser, Color Printers

Image #	Item # 100 Sht	Item # 250 Sht	Item # 1,000 Sht	Label Size	Label Across	Labels Down	Labels/ Sht	Labels/ 100 Ctn	Labels/ 250 Ctn	Labels/ 1,000 Ctn
9	371010	-	-	2-5/8 X 1	3	10	30	3000	-	-
15	371099	-	-	8-1/2 X 5-1/2	2	1	2	200	-	-
14	371088	-	-	8-1/2 X 11	1	1	1	100	-	-
Approximate weight for the above products									2.7 lbs	

## Clear Matte Polyester • Permanent Adhesive • Inkjet Printer Only

Image #	Item # 100 Sht	Item # 250 Sht	Item # 1,000 Sht	Label Size	Label Across	Labels Down	Label/ Sht	Labels/ 100 Ctn	Labels/ 250 Ctn	Labels/ 1,000 Ctn
13	370258	-	-	8-1/2 x 11	1	1	1	100	-	-
14	378123	-	-	8-1/2 x 11	1	1	1	100	-	-
Approximate weight for the above products									2.4 lbs	

## Weather Resistant Polyester • Permanent Adhesive • Inkjet Printer Only

Image #	Item # 100 Sht	Item # 250 Sht	Item # 1,000 Sht	Label Size	Label Across	Labels Down	Label/ Sht	Labels/ 100 Ctn	Labels/ 250 Ctn	Labels/ 1,000 Ctn
15	371101	-	-	8-1/2 X 5-1/2	1	2	2	200	-	-
13	371000	-	-	8-1/2 x 11	1	1	1	100	-	-
Approximate weight for the above products									2.4 lbs	

## Legal Size • 8-1/2" x 14" • White Paper • Permanent Adhesive • Inkjet, Laser, Color Printer, Copiers

Image #	Item # 100 Sht	Item # 250 Sht	Item # 1,000 Sht	Label Size	Labels Across	Labels Down	Label/ Sht	Labels/ 100 Ctn	Labels/ 250 Ctn	Labels/ 1,000 Ctn
16	313907	332651	-	4 x 6	2	2	4	400	1,000	
17	310105	330107	-	4-1/4 x 13	2	1	2	200	500	
Approximate weight for the above products									2.8 lbs	6.4 lbs

# Traditional Sheeted Labels (non FABTab™)

8-1/2" x 11" Sheet

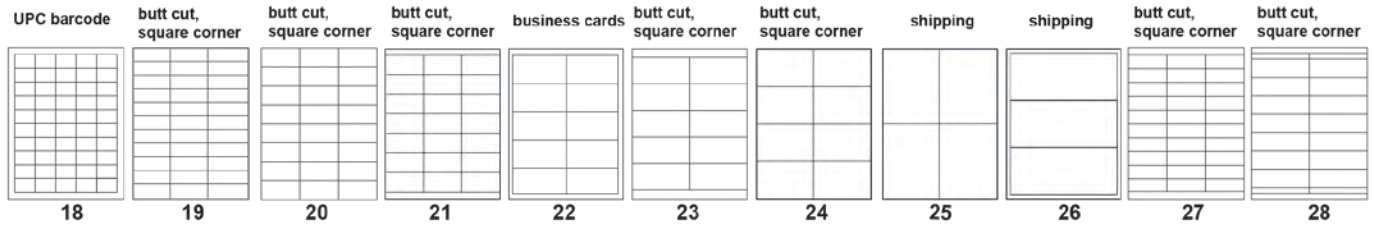

## Standard White 50lbs Paper • Permanent Adhesive • Inkjet, Laser, Color Printer, Copiers

Image #	Item # 100 Sht	Item # 250 Sht	Item # 1,000 Sht	Label Size	Labels Across	Labels Down	Labels/ Sht	Labels/ 100 Ctn	Labels/ 250 Ctn	Labels/ 1,000 Ctn
18	310151	330153	-	1-1/2 x 1	5	10	50	5,000	12,500	-
19	311308	330906	318712	2-5/6 x 1	3	11	33	3,000	8,250	33,000
27	-	-	318756	2-5/6 x 1	3	10	30	-	-	30,000
20	311253	330851	318701	2-5/6 x 1-3/8	3	8	24	2,400	6,000	24,000
21	311354	330952	318745	2-5/6 x 1-1/2	3	7	21	2,100	5,250	21,000
22	311455	331053	-	3-1/2 x 2	2	5	10	1,000	2,500	-
23	312603	331806	318778	4-1/4 x 2	2	5	10	1,000	2,500	10,000
24	312658	331852	318767	4-1/4 x 2-3/4	2	4	8	800	2,000	8,000
25	312704	331907	318677	4-1/4 x 5-1/2	2	2	4	400	1,000	4,000
26	313007	332054	318666	8 x 3-1/2	1	3	3	300	750	3,000
Approximate weight for the above products								2.1 lbs	5.2 lbs	20 lbs

## Clear Matte Polyester • Permanent Adhesive • Inkjet Printer Only

Image #	Item # 100 Sht	Item # 250 Sht	Item # 1,000 Sht	Label Size	Label Across	Labels Down	Labels/ Sht	Labels/ 100 Ctn	Labels/ 250 Ctn	Labels/ 1,000 Ctn
23	370203	-	-	4-1/4 x 2	2	5	10	1,000	-	-
27	370056	-	-	2-5/6 x 1	3	10	30	3,000	-	-
28	370157	-	-	4-1/4 x 1-1/3	2	7	14	1,400	-	-
Approximate weight for the above products								2.4 lbs		

## Specialty Die Cut Labels

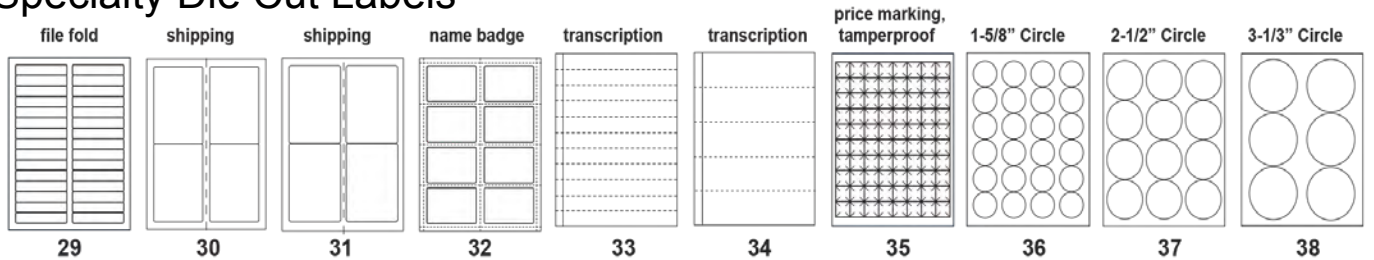

## Standard White 50lbs Paper • Permanent Adhesive • Inkjet, Laser, Color Printer, Copiers

Image #	Item # 100 Sht	Item # 250 Sht	Item # 1,000 Sht	Label Size	Labels Across	Labels Down	Labels/ Sht	Labels/ 100 Ctn	Labels/ 250 Ctn	Labels/ 1,000 Ctn
29	313650	332458	-	3-7/16 x 2/3	2	15	30	3,000	7,500	-
30	312524	-	340782	3-1/2 x 5	2	2	4	400	-	4,000
31	312502	331751	318688	4 x 5	2	2	4	400	1,000	4,000
32	313806	332550	-	3-3/8 x 2-1/3	2	4	8	800	2,000	-
33	312906	-	-	8 x 1	1	11	11	1,100	-	-
34	312952	-	-	8 x 2	1	5	5	500	-	-
35	310050	330052	-	1 x 1	8	10	80	8,000	20,000	-
Approximate weight for the above products								2.1 lbs	6.5 lbs	20 lbs

## Standard White 50lbs Paper • 8-1/2" x 11" Permanent Adhesive • Inkjet, Laser, Color Printer, Copiers

Image #	Item # 100 Sht	Item # 250 Sht	Item # 1,000 Sht	Label Size	Label Across	Labels Down	Labels/ Sht	Labels/ 100 Ctn	Labels/ 250 Ctn	Labels/ 1,000 Ctn
36	310307	330254	-	1-5/8	4	6	24	2,400	6,000	-
37	310656	330557	318723	2-1/2	3	4	12	1,200	3,000	12,000
38	311657	331200	-	3-1/3	2	3	6	600	1,500	-
Approximate weight for the above products								2.1 lbs	6.5 lbs	20 lbs

For use in inkjet printers, laser printers, copiers, offset presses and most digital printers. Features Lay Flat Liner.



## Standard White 50lbs Paper • Permanent Adhesive • Inkjet, Laser, Color Printer

Image #	Item # 100 Sht	Item # 250 Sht	Item # 1,000 Sht	Label Size	Labels Across	Labels Down	Labels/ Sht	Labels/ 100 Ctn	Labels/ 250 Ctn	Labels/ 1,000 Ctn
39	310444	-	-	1-1/2 x 1-1/2	4	-	80	8,000	-	-
40	310555	330502	340053	1-3/4 x 1/2	4	20	80	8,000	20,000	80,000
41	318554	318565	318576	1-3/4 x 2/3	4	15	60	6,000	15,000	60,000
42	310723	-	-	2 x 2	5	-	12	1,200	-	-
43	310904	330805	340108	2-5/8 x 1	3	10	30	3,000	7,500	30,000
44	311951	331503	340154	4 x 1	2	10	20	2,000	5,000	20,000
45	312006	331558	318734	4 x 1-1/3	2	7	14	1,400	3,500	14,000
46	312052	331604	318690	4 x 1-1/2	2	7	14	1,400	3,500	14,000
47	312107	331650	340200	4 x 2	2	5	10	1,000	2,500	10,000
48	312208	331705	340255	4 x 3-1/3	2	3	6	600	1,500	6,000

Approximate weight for the above products

2.6 lbs    6.4 lbs    25 lbs

## Standard White 50lbs Paper • Removable Adhesive • Inkjet, Laser, Color Printer

Image #	Item # 100 Sht	Item # 250 Sht	Item # 1,000 Sht	Labels Size	Labels Across	Labels Down	Labels/ Sht	Labels/ 100 Ctn	Labels/ 250 Ctn	Labels/ 1,000 Ctn
41	310950	331367	345737	2-5/8 x 1	3	10	30	3,000	7,500	30,000
46	312153	331378	345726	4 x 2	2	5	10	1,000	2,500	10,000

Approximate weight for the above products

2.6 lbs    6.4 lbs    25 lbs

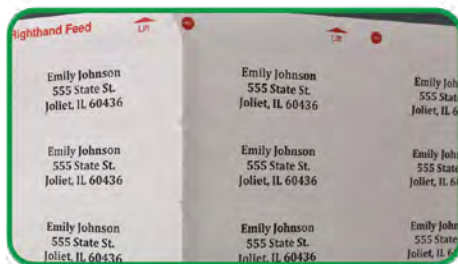

**FOLD**  
To Expose

**FABTab™**

Remove as many labels as desired from the sheet. Then reset to reuse or reprint later.



**PEEL**  
Labels

High Performance in laser printers, Inkjet printers, copiers and offset presses.

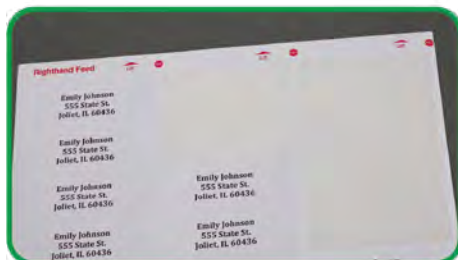

**RESET**  
To Expose

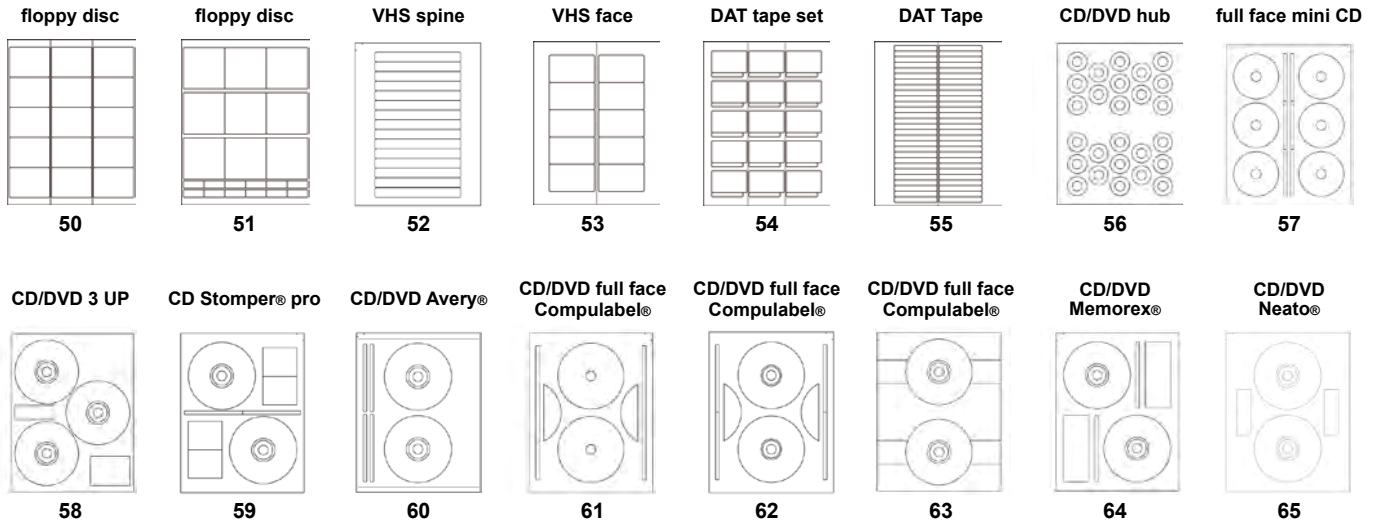

Standard White 50lbs Paper • Permanent Adhesive • Inkjet, Laser, Color Printers

Image #	Item # 100 Sht	Item # 250 Sht	Label Size	Description	Labels Across	Labels Down	Labels/ Sht	Labels/ 100 Ctn	Labels/ 250 Ctn
50	311501	331108	2-11/16 x 2	3-1/2" Floppy Disk	3	5	15	1,500	3,750
51	311400	331007	2-3/4 x 2-3/4	3-1/2" Floppy Disk	3	3	9	900	2,250
52	312851	332008	6 x 2/3	VHS Tape Spine	1	15	15	1,500	3,750
53	311602	331154	3 x 1-7/8	VHS Tape Face	2	5	10	1,000	2,500
Approximate weight for the above products								2.1 lbs	5.7 lbs

Standard White 50lbs Paper • Removable Adhesive • Inkjet, Laser, Color Printers

Image #	Item # 100 Sht	Item # 250 Sht	Label Size	Description	Labels Across	Labels Down	Labels/ Sht	Labels/ 100 Ctn	Labels/ 250 Ctn
50	310601	-	2-3/8 x 2	Zip Disk	3	5	15	1,500	-
54	310252	-	2-3/8 x 1-3/4	4mm DAT Tape Set	3	5	15	1,500	-
55	311556	-	2-7/8 x 3/8	8mm Data Tape	2	28	56	5,600	-
Approximate weight for the above products								2.1 lbs	

Standard White 50lbs Paper • Permanent Adhesive • Inkjet, Laser, Color Printers

Image #	Item # 100 Sht	Item # 250 Sht	Diameter	Description	Labels/ Sht	Labels/ 100 Ctn	Labels/ 250 Ctn
56	312862	-	1-1/3	CD/DVD Hub	26	2,600	-
57	312827	-	3	Full Face Mini CD	6	600	-
58	312737	-	4-1/2	HP® CD/DVD 3-up	3	300	-
59	312715	-	4-5/8	CD Stomper® Pro	2	200	-
60	312660	-	4-5/8	CD/DVD Avery® 5931	2	200	-
61	312840	-	4-9/16	CD/DVD Compulabel® Full Face	2	200	-
62	312636	-	4-9/16	CD/DVD Compulabel®	2	200	-
63	312750	331920	4-9/16	CD/DVD Compulabel®	2	200	500
64	312748	-	4-5/8	CD/DVD Memorex®	2	200	-
65	312693	-	4-5/8	CD/DVD Neato®	2	200	-
Approximate weight for the above products						2.1 lbs	5.7 lbs



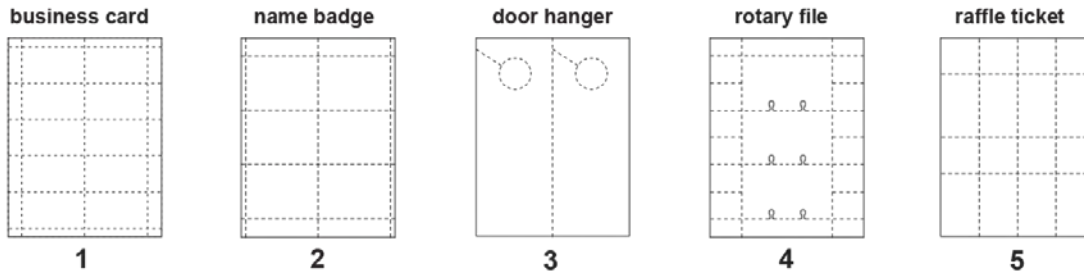

Cardstock Layouts • 7pt Index • Inkjet, Laser Printers, Micro Perforated

Image #	Item # 100 Sht	Item # 250 Sht	Label Size	Color	Cards Across	Cards Down	Cards/ Sht	Cards/ 100 Ctn	Cards/ 250 Ctn
1	410106	430108	3-1/2 x 2	White	2	5	10	1,000	2,500
2	410354	430356	4 x 3	White	2	3	6	600	1,500
3	411254	431201	4-1/4 x 11	White	2	1	2	200	500
4	410455	430457	5 x 3	White	1	3	3	300	750
Approximate weight for the above products								2.4 lbs	5.7 lbs

Raffle Ticket • 7pt Index • 50 Sheets per carton Inkjet, Laser Printers, Micro Perforated

Image #	Item # 50 Sht	Label Size	Color	Cards Across	Cards Down	Cards/ Sht	Cards/ Ctn
<b>Software Kit and Ticket</b>							
5	411208	2-1/8 x 5-1/2	White	4	4	8	400
<b>Ticket Refill Only</b>							
5	411210	2-1/8 x 5-1/2	White	4	4	8	800
Approximate weight for the above products							1.3 lbs

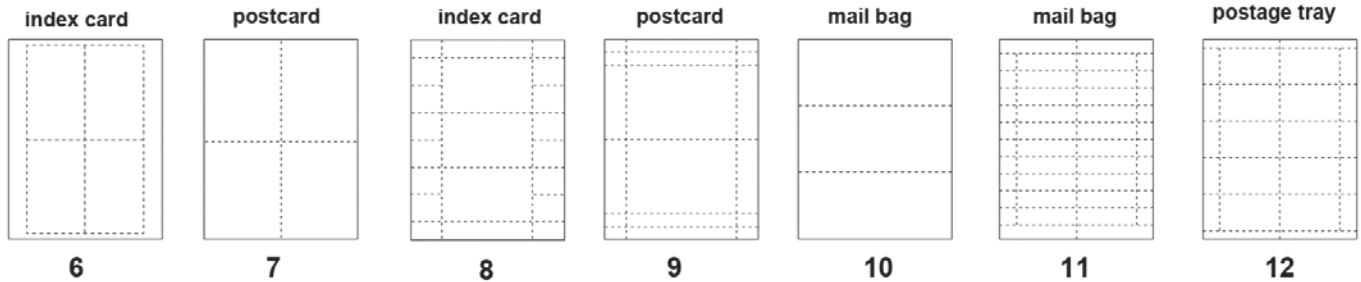

Index and Post Card • 7pt Index • Inkjet, Laser Printers • Micro Perforated

Image #	Item # 100 Sht	Item # 250 Sht	Label Size	Color	Cards Across	Cards Down	Cards/ Sht	Cards/ 100 Ctn	Cards/ 250 Ctn
6	410051	430053	3 x 5	White	2	2	4	400	1,000
7	410556	430558	4-1/4 x 5-1/2	White	2	2	4	400	1,000
8	410501	430503	5 x 3	White	1	3	3	300	750
9	410657	430604	6 x 4	White	1	2	2	200	500
10	410905	-	8-1/2 x 3-2/3	White	1	3	3	300	-
11	410207	430200	3-1/3 x 15/16	White	2	10	20	2,000	5,000
11	410253	430255	3-1/3 x 15/16	Cherry	2	10	20	2,000	5,000
12	410308	430301	3-1/3 x 2	White	2	5	10	1,000	2,500
1	410117	430110	3-1/2 x 2	White	2	5	10	1,000	2,500
Approximate weight for the above products								2.4 lbs	5.7 lbs

# Pinfeed Labels

## 50lb Smudge proof White Face Stock

Item #	Label Size	Labels Across	Perf	Carrier Width	Fold Depth	Labels/ Carton	Carton Wt. lbs
140657	1-1/2 x 7/16	6	V	10-1/2	12	60,000	12.8
140051	2 x 7/16	4	V	9	12	40,000	11.4
110507	2-1/2 x 15/16	1	H	3-1/4	12	5,000	3.9
120104	2-1/2 x 15/16	2	V	6	12	10,000	7.6
130206	2-1/2 x 15/16	3	V	8-1/2	12	15,000	12.0
140556	2-1/2 x 15/16	5	V	14	12	25,000	17.6
110158	2-3/4 x 7/16	1	H	3-1/2	12	10,000	4.1
140106	2-3/4 x 7/16	4	V	12-1/4	12	40,000	15.3
111003	2-3/4 x 1-7/16	1	H	3-1/2	12	5,000	6.5
111058	2-3/4 x 1-7/16	1	H	3-1/2	12	5,000	6.7
111554	2-3/4 x 2-3/4	1	H	3-1/2	12	2,500	6.5
110608	3 x 15/16	1		3-3/4	12	5,000	4.6
140308	3 x 15/16	4	V	13	12	20,000	16.7
110204	3-1/2 x 7/16	1		4-1/4	12	10,000	5.0
110654	3-1/2 x 15/16	1		4-1/4	12	5,000	5.1
110700	3-1/2 x 15/16	1	H	4-1/4	12	5,000	5.2
120150	3-1/2 x 15/16	2	V	8	12	10,000	10.4
130307	3-1/2 x 15/16	3	V	11-1/2	12	15,000	14.8
140400	3-1/2 x 15/16	4	V	15	12	20,000	19.1
162505	3-1/2 x 15/16 removable adh	1		4-1/4	12	5,000	4.7
111104	3-1/2 x 1-7/16	1		4-1/4	12	5,000	8.0
120352	3-1/2 x 1-7/16	2	V	8	12	10,000	15.4
130408	3-1/2 x 1-7/16	3	V	11-1/2	12	15,000	24.4
140354	3-1/3 x 15/16	4	V	14-5/8	12	20,000	18.7
140455	3-1/5 x 9/10	4	V	14	12	20,000	17.6
111352	3-1/2 x 1-15/16	1		4-1/4	12	5,000	10.5
120205	4 x 15/16	2	V	9	12	10,000	10.4
120251	4 x 15/16	2	V	9-1/2	12	10,000	11.8
110755	4 x 15/16	1		4-3/4	12	5,000	5.9
130353	4 x 15/16	3		13	12	15,000	16.6
120407	4 x 1-7/16	2		9	12	10,000	17.4
111150	4 x 1-7/16	1		4-3/4	12	5,000	8.8
111407	4 x 1-15/16	1		4-3/4	12	5,000	11.8
120453	4 x 1-15/16	2	V	9	12	10,000	23.1
130500	4 x 1-15/16	3	V	13	12	15,000	34.3
130454	4 x 1-7/16	3	H	13	12	15,000	25.5
111600	4 x 2-15/16	1	H	4-3/4	12	2,500	9.0
120508	4 x 2-15/16	2	H	9	12	5,000	17.9
111508	4 x 2-7/16	1	H	4-3/4	10	2,500	7.5
130555	4 x 2-15/16	3	H	13	12	7,500	25.7
111655	4-1/4 x 2-15/16	1	H	5	12	2,500	9.3
110305	5 x 7/16	1		5-3/4	12	10,000	7.3
110801	5 x 15/16	1		5-3/4	12	5,000	7.4
120306	5 x 15/16	2	V	11	12	10,000	14.1
111453	5 x 1-15/16	1	H	5-3/4	12	5,000	14.7
111701	5 x 2-15/16	1	H	5-3/4	12	2,500	11.2
120554	5 x 2-15/16	2	H	11	12	5,000	22.1
111802	5 x 3-7/16	1	H	5-3/4	10-1/2	2,500	12.9
111857	5 x 3-15/16	1	H	5-3/4	12	2,500	14.8
111903	6 x 3-15/16	1	H	6-3/4	12	2,500	17.1
120655	6 x 3-15/16	2	H	13	12	5,000	33.9
112004	6 x 5-15/16	1	H	6-3/4	12	1,000	10.8
111958	6-1/2 x 3-15/16	1	H	7-1/2	12	2,500	19.2
120701	6-1/2 x 3-15/16	2	H	14	12	5,000	38.5
110351	7-3/4 x 7/16	1		8-1/2	12	10,000	10.5
110856	7-3/4 x 15/16	1		8-1/2	12	5,000	11.0
112105	8-1/2 x 10-15/16	1	H	9-1/2	11	500	13.7

V = Vertical H = Horizontal

# Pinfeed Labels

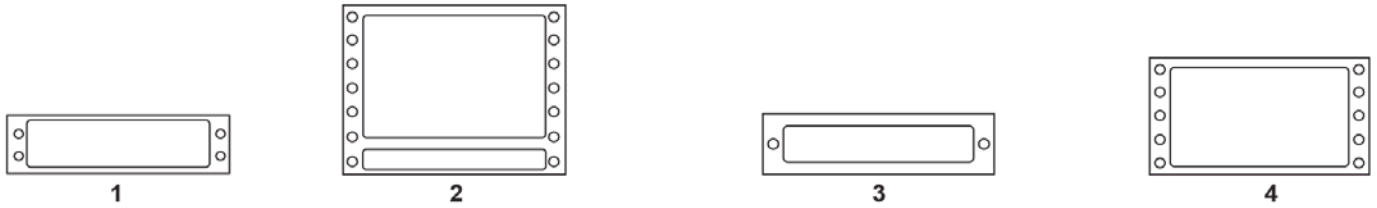

Tape Reel • 50lb Latex Face Stock • One Across • Removable Adhesive • Perforated

Image #	Item #	Label Size	Carrier Width	Fold Depth	Labels/ Ctn	Weight
1	170357	3-1/2 x 15/16	4-1/4	12	5,000	5.3
1	170201	3-1/2 x 1-7/16	4-1/4	12	5,000	8.2
1	170403	4 x 1-7/16	4-3/4	12	5,000	8.9
2	170302	3-3/4 x 2-7/8	4-1/4	10-1/2	2,500	8.7
with 3/8" tab						

Media • 50lb Smudge proof White Face Stock • One Across • Adhesive • Perf at fold 12"

Image #	Item #	Label Size	Description	Carrier Width	Fold Depth	Labels/ Ctn	Weight
3	180055	3-1/2 x 5/8	File Folder	4-1/4	12	5,000	3.5
4	111306	2-3/4 x 1-15/16	Diskette	3-1/2	12	5,000	8.7

Special Materials as shown below

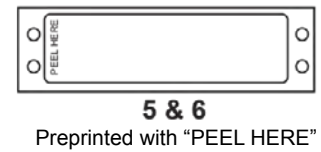

Image #	Item #	Label Size	Description	Carrier Width	Fold Depth	Labels/ Ctn	Weight
5	162404	3-1/2 x 15/16	Piggyback	4-1/4	12	3,000	4.4
6	162358	3-1/2 x 15/16	Duo-Image	4-1/4	12	3,000	4.5

Transcription • 50lb Smudge proof White Face Stock • Permanent Adhesive • Perforated



Item #	Label Size	Labels Across	Carrier Width	Fold Depth	Labels/ Ctn	Weight
160356	7-3/4 x 2	1	8-1/2	12	1,250	6.1
160503	7-3/4 x 12	1	8-1/2	12	200	5.8

Price Marketing • 50lb Smudge proof White Face Stock • Permanent Adhesive • Perforated



Item #	Label Size	Labels Across	Carrier Width	Fold Depth	Labels/ Ctn	Weight
160806	1 x 15/16	12	13	12	100,000	28.0
161100	1 x 15/16	8	9-1/2	12	50,000	15.3
161155	1 x 15/16	6	7	12	50,000	15.3

# Pinfeed Labels

Label Colors • 50lb Face Stock • Permanent Adhesive • Inkjet, Laser, Color Printers, Copiers

Item #	Label Size	Labels Across	Perf	Color	Carrier Width	Fold Depth	Labels/Ctn	Weight
161256	3-1/2 x 15/16	1		FL Green	4-1/4	12	5,000	5.2
161357	3-1/2 x 15/16	1		FL Red	4-1/4	12	5,000	5.2
161403	3-1/2 x 15/16	1		FL Yellow	4-1/4	12	5,000	5.2
161458	3-1/2 x 15/16	1		FL Orange	4-1/4	12	5,000	5.2
112454	3-1/2 x 15/16	1		Pastel Pink	4-1/4	12	5,000	5.2
112500	3-1/2 x 15/16	1		Pastel Green	4-1/4	12	5,000	5.2
112555	3-1/2 x 15/16	1		Pastel Yellow	4-1/4	12	5,000	5.2
112601	3-1/2 x 15/16	1		Pastel Blue	4-1/4	12	5,000	5.2
120745	3-1/2 x 15/16	1		Orange	4-1/4	12	5,000	5.2
120756	3-1/2 x 15/16	1		Red	4-1/4	12	5,000	5.2
161504	4 x 1-7/16	1		FL Green	4-3/4	12	5,000	8.9
161651	4 x 1-7/16	1		FL Yellow	4-3/4	12	5,000	8.9
161752	4 x 2-15/16	1	H	FL Green	4-3/4	12	2,500	8.9
161908	4 x 2-15/16	1	H	FL Yellow	4-3/4	12	2,500	8.9
162000	5 x 2-15/16	1	H	FL Green	5-3/4	12	2,500	11.1
162055	5 x 2-15/16	1	H	FL Pink	5-3/4	12	2,500	11.1
162101	5 x 2-15/16	1	H	FL Red	5-3/4	12	2,500	11.1
162156	5 x 2-15/16	1	H	FL Yellow	5-3/4	12	2,500	11.1
162202	5 x 2-15/16	1	H	FL Orange	5-3/4	12	2,500	11.1

H = Horizontal

# Pinfeed Cards

90lb Cardstock Colors • 7 pt Index • Perforated • Standard Industry Colors

Item #	Card Size	Cards Across	Color	Carrier Width	Fold Depth	Labels/Ctn	Weight
210104	4 x 3	1	White	5	12	4,000	13.4
210150	5 x 3	1	White	6	12	4,000	16.8
210205	5 x 3	1	Blue	6	12	4,000	16.8
210251	5 x 3	1	Canary	6	12	4,000	16.8
210306	5 x 3	1	Green	6	12	4,000	16.8
210352	5 x 3	1	Pink	6	12	4,000	16.8
210407	5 x 3	1	Salmon	6	12	4,000	16.8
211904	5 x 3	1	White	6	12	5,000	16.8
210701	5 x 3	2	Salmon	11	12	8,000	30.8
210453	5 x 3	2	White	11	12	8,000	30.1
210508	5 x 3	2	Blue	11	12	8,000	30.1
210554	5 x 3	2	Canary	11	12	8,000	30.1
210600	5 x 3	2	Green	11	12	8,000	30.1
210802	6 x 3-1/2	1	White	7	10-1/2	3,000	16.6
210857	6 x 4	1	White	7	12	4,000	23.6
210903	6 x 4	1	Blue	7	12	4,000	23.6
210958	6 x 4	1	Canary	7	12	4,000	23.6
211004	6 x 4	1	Green	7	12	4,000	23.6
211050	6 x 4	1	Pink	7	12	4,000	23.6
211105	6 x 4	1	Salmon	7	12	4,000	23.6
211206	6 x 4	2	White	13	12	6,000	34.8
211500	7-3/8 x 3-1/4	1	White	8-1/2	13	4,000	25.1
211601	8 x 5	1	White	9	10	3,000	31.3

# Mailing

Pinfeed Cheshire Mailing Label • Four Across • Permanent Adhesive

Item #	Label Size	Carrier Width	Fold Depth	Labels/ Carton	Weight
140758	3-1/5 x .87	14-7/8	12	40,000	35.3
140703	3-1/5 x .92	14-7/8	12	20,000	18.6
140905	3-1/5 x .92	14-7/8	12	40,000	37.2
140850	3-1/5 x 1-3/8	14-7/8	12	20,000	28.3

Pinfeed Mail Bag and Tray Tag

One Across • 7pt Tag • Perforated

Item #	Label Size	Color	Carrier Width	Fold Depth	Labels/ Carton	Weight
250053	3-2/5 x 15/16	White	4-1/2	7-1/2	24,000	22.2
250457	3-2/5 x 1-7/8	White	4-1/2	7-1/2	12,000	22.2

Four Across • 7pt Tag • Perforated

Item #	Label Size	Color	Carrier Width	Fold Depth	Labels/ Carton	Weight
250503	3-2/5 x 1-7/8	White	14-7/8	7-1/2	16,000	24.7
250356	3-1/3 x 2	White	14-7/8	12	20,000	32.8

## Wafer Seals

Timing Marks on Liner

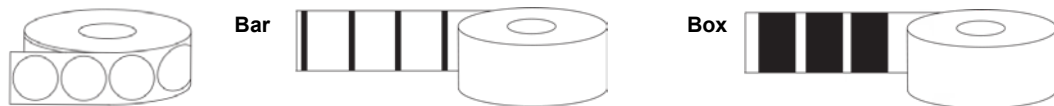

Uncoated White Paper • 3" Core • Permanent Adhesive

Item #	Diameter	Outside Diameter	Timing Marks	Labels/ Rolls	Rolls/ Ctn	Labels/ Ctn	Weight
910102*	1	6-1/2	none	3,125	16	50,000	19.6
910056	1	8	none	5,000	10	50,000	14.7
910271	1-1/2	7-7/10	none	4,000	15	60,000	15.0

\*Pinfeed Product

Clear Poly • 3" Core • Permanent Adhesive

Item #	Diameter	Outside Diameter	Timing Marks	Labels/ Rolls	Rolls/ Carton	Labels/ Ctn	Weight
910552	1	6	bar	5,000	10	50,000	10.8
910541	1-1/2	6-1/2	bar	5,000	10	50,000	10.8

Translucent Paper • 3" Core • Permanent Adhesive

Item #	Diameter	Outside Diameter	Timing Marks	Labels/ Rolls	Rolls/ Carton	Labels/ Ctn	Weight
910203	1	7	box	5,000	10	50,000	12
910473	1	12	bar	20,000	5	100,000	23
910585	1	16-1/2	bar	40,000	5	200,000	46
910416	1-1/2	7	box	4,000	15	60,000	29
910427	1-1/2	10-1/2	bar	10,000	4	40,000	19
910438	1-1/2	16	bar	20,000	4	80,000	30
910596	1-1/2	17	bar	30,000	4	120,000	46
910405	2	16-1/2	bar	7,500	3	22,500	46

# Ordering Checklist

1. Your distributor account number.
2. Your PO number and your customer's PO number, if applicable.
3. Item number, label size, and number of cartons (1 carton minimum).
4. Address we are shipping to: you or your customer.
5. How you would like it shipped.

## Is your roll wound in or wound out?

If you're doing a custom job, the drawings have options for how the copy can run. When placing custom orders for rolls, choose the proper position number to ensure your customers get their labels the way they want them!

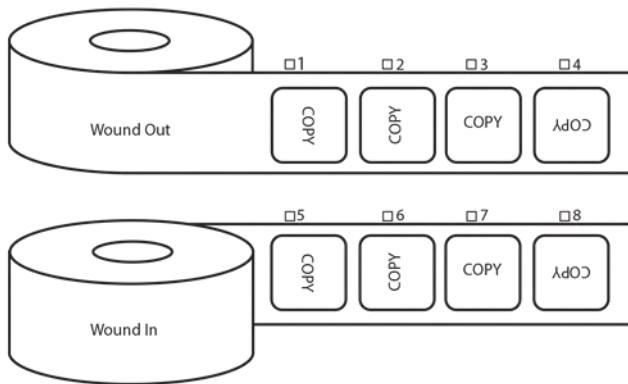

# Terms and Conditions

## Pricing & Payment:

All prices are listed in U.S. dollars and are subject to sales tax if no valid resale certificate is on file. Non-exempt conditions will be determined by governing jurisdiction. Sales tax is not included in standard pricing. Prices may change without notice. Freight costs, custom duties, tariffs, and freight forwarder expenses are not included in the price of products. Customized labeling of stock product is \$0.35/carton with a minimum of \$10. For cancellations, the customer is responsible for expenses incurred by Continental Datalabel® up to the time of cancellation.

## Shipping:

All shipments are FOB our factories or regional distribution centers. Unless otherwise specified, Continental Datalabel® will suitably prepare all shipments to secure the lowest transportation rates.

## Returned Goods:

All returns require prior validation and a Returns Goods Authorization (RGA) Number to be issued. All returns must be clearly marked with this authorization number or the return will not be accepted and any freight charges incurred will be the originator's responsibility. Shipments must have each box marked clearly indicating the RGA number. For skid shipments, the skid must be marked with the RGA number on a placard on at least (2) sides of the skid. The distributor will be responsible for making arrangements with the parcel service or trucking company to return products that were not the responsibility of the manufacturer or of CDL processing of the order. Returned product deemed to be within CDL's specifications/non-defective or due to customer error is subject to a restocking fee. No freight credit will be issued. Special order ribbons will incur a 55% restocking fee. RGA's will expire 30 days from the issue date and returns will not be accepted after the expiration date. Continental Datalabel® reserves the right to refuse returns for any reason.



## Contact Us:

**847-628-8300**

**sales@communicolor.com**

**www.communicolor.com**

## Manufacturing & Distribution

### Midwest

1855 Fox Lane  
Elgin, IL 60123

### Southwest

9602 Dilworth Rd  
Dallas, TX 75243

### West

211 Business Center Ct  
Redlands, CA 92373

## Distribution Centers

### East

69 Veronica Ave  
Ste 6C  
Somerset, NJ 08873

### Southeast

1775 Breckinridge  
Pkwy Ste 300  
Duluth, Ga 30096

Our nationwide distribution support centers are available from 8am to 5pm CST Monday through Friday.

# DIGITAL PRINTING



## Speed

By eliminating the use of plates, a digital run drastically reduces the overall runtime for a custom job. What would normally take several hours to print on a flexographic run can instead be accomplished in minutes!

## Quality

The finished quality of a digitally printed label will consistently outshine that of a flexographic print. Our HP-Indigo press can print at 230 line screen, which is close to double that of a flexographic print! If you're looking for a vibrant, high-resolution print, go digital!

## Cost

Running digitally eliminates the need for plates, film to output, and requires minimal machine setup. These factors keep digital jobs at a cost-effective price that you can't beat!

## Flexibility

Digital printing's greatest power is its flexibility; you can print thousands of custom labels, each containing different data. That's right – completely variable data printing! Everything from consecutive numbers, multiple barcodes, names from a database, or even just several versions of the same label.